

**INSTRUCTIONS FOR USE**  
**STEQEYMA (ste-qey-ma)**  
**(ustekinumab-stba)**  
**injection, for subcutaneous use**

**Instructions for injecting STEQEYMA using a prefilled syringe.**

**This Instructions for Use contains information on how to inject STEQEYMA. Read and follow this Instructions for Use before you start using STEQEYMA. Your doctor or nurse should show you how to prepare and give your injection of STEQEYMA the right way.**

If you cannot give yourself the injection:

- ask your doctor or nurse to help you, or
- ask someone who has been trained by a doctor or nurse to give your injections.

**Do not** try to inject STEQEYMA yourself until you have been shown how to inject STEQEYMA by your doctor, nurse or health professional.

STEQEYMA prefilled syringes are available in 2 dose strengths (see **Figure A**). These instructions can be used for both dose strengths.

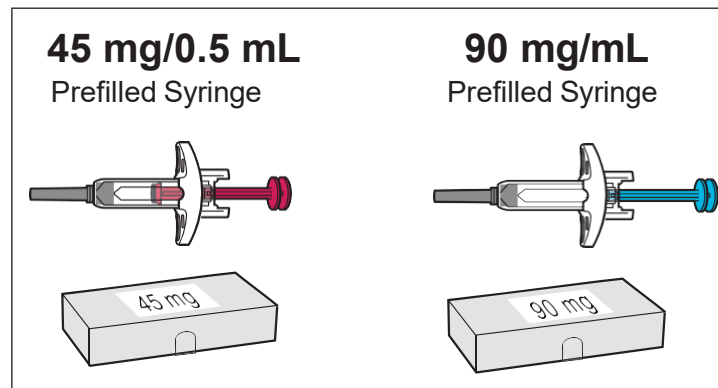

**Figure A**

**Important Information**

- Before you start, check the carton to make sure that it is the right dose. You will have either 45 mg or 90 mg as prescribed by your doctor.
  - If your dose is 45 mg, you will receive one 45 mg prefilled syringe.
  - If your dose is 90 mg, you will receive either one 90 mg prefilled syringe or two 45 mg prefilled syringes. **If you receive two 45 mg prefilled syringes for a 90 mg dose, you will need to give yourself two injections, one right after the other.**
- Children 12 years of age and older with psoriasis who weigh 132 pounds or more may use a prefilled syringe.
- Do not use the prefilled syringe if the liquid is discolored, cloudy, or has large particles. Get a new prefilled syringe.
- **Do not shake the prefilled syringe at any time.** Shaking your prefilled syringe may damage your STEQEYMA medicine. If your prefilled syringe has been shaken, **do not** use it. Get a new prefilled syringe.
- To reduce the risk of accidental needle sticks, each prefilled syringe has a needle guard that is automatically activated to cover the needle after you have given your injection. **Do not** pull back on the plunger rod at any time.

**Storing STEQEYMA**

- Store the STEQEYMA prefilled syringe in a refrigerator between 36°F to 46°F (2°C to 8°C).
- Store STEQEYMA in the original carton to protect it from light until time to use it.
- Do not freeze STEQEYMA.
- Do not shake STEQEYMA.
- If needed, individual STEQEYMA prefilled syringes may be stored at room temperature up to 86°F (30°C) for a maximum single period of up to 15 days in the original carton to protect from light. Record the date when the prefilled syringe is first removed from the refrigerator on the carton in the space provided. When a syringe has been stored at room temperature, it should not be returned to the refrigerator. Throw away (discard) the syringe if

not used within 15 days at room temperature storage. Do not use STEQEYMA after the expiration date on the carton or the prefilled syringe.

- **Keep STEQEYMA and all medicines out of the reach of children.**

### Parts of the Prefilled Syringe (see Figure B)

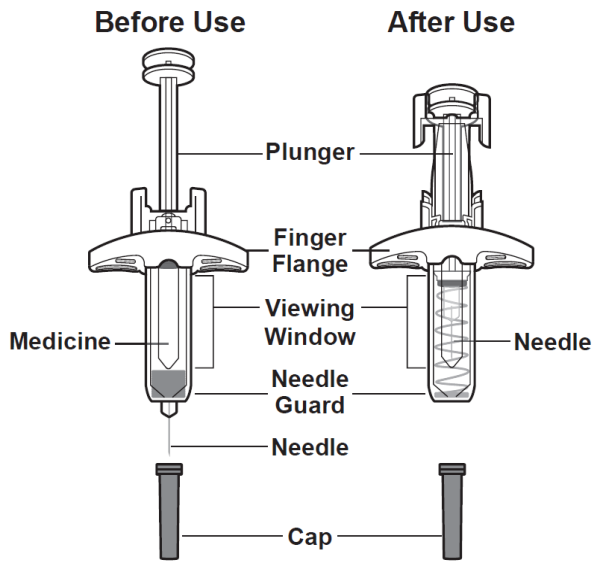

Figure B

### Preparing to Inject STEQEYMA

<p>Carton containing prefilled syringe</p> <p>Cotton ball or gauze and alcohol swab</p> <p>Adhesive bandage</p> <p>Sharps disposal container</p>	<p><b>1. Gather the supplies for the injection</b></p> <p>1.a. Prepare a clean, flat surface, such as a table or counter top, in a well-lit area.</p> <p>1.b. Take the carton(s) containing the prefilled syringe(s) needed to administer your prescribed dose out of the refrigerator. Each STEQEYMA carton contains 1 prefilled syringe.</p> <p>Note: Depending on the dose prescribed to you by your healthcare provider you may need to prepare 1 or more prefilled syringes and inject the contents of them all.</p> <p>1.c. Make sure you have the following supplies (see <b>Figure C</b>)</p> <ul style="list-style-type: none"><li>- Carton containing prefilled syringe</li></ul> <p><b>Not included in the carton:</b></p> <ul style="list-style-type: none"><li>- Cotton ball or gauze</li><li>- Adhesive bandage</li><li>- FDA-cleared sharps disposal container</li><li>- Alcohol swab</li></ul>
<p>EXP: YYYY/MM</p>	<p><b>2. Check the expiration date on the carton (see Figure D).</b></p> <ul style="list-style-type: none"><li>• <b>Do not</b> use it if the expiration date has passed. If the expiration date has passed, safely throw away (dispose of) the carton in an FDA-cleared sharps disposal container (see step 13. <b>Throw away (dispose of) STEQEYMA</b>).</li></ul>

Figure D

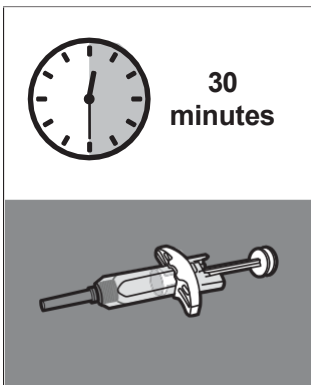

Figure E

**3. Wait 30 minutes.**

- 3.a. Open the carton. Gripping from the syringe body, lift the prefilled syringe from the carton.
- 3.b. Leave the prefilled syringe outside of the carton at room temperature 68°F to 77°F (20°C to 25°C) for 30 minutes to allow it to warm up (see **Figure E**).
- **Do not** warm the prefilled syringe using heat sources such as hot water or a microwave.
  - If the prefilled syringe does not reach room temperature, this could cause the injection to feel uncomfortable and make it hard to push the plunger.

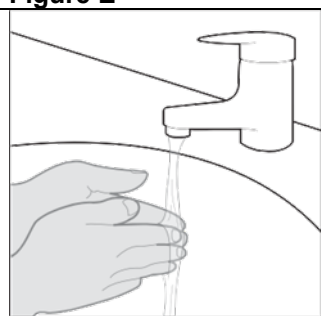

Figure F

**4. Wash your hands.**

- 4.a. Wash your hands with soap and water and dry them thoroughly (see **Figure F**).

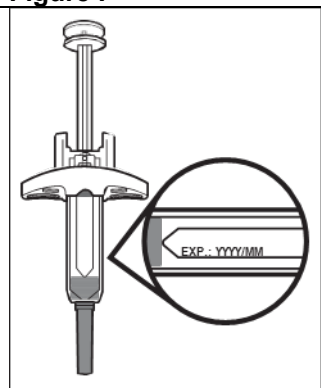

Figure G

**5. Inspect the prefilled syringe.**

- 5.a. Look at the prefilled syringe and make sure you have the correct medicine (STEQEYMA) and dosage.
- 5.b. Look at the prefilled syringe and make sure it is not cracked or damaged.
- 5.c. Check the expiration date on the label of the prefilled syringe (see **Figure G**).
- **Do not** use if the expiration date has passed.

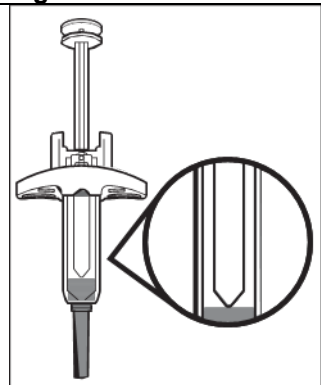

Figure H

**6. Inspect the medicine.**

- 6.a. Look at the medicine and make sure that the liquid is clear to slightly opalescent and colorless to pale yellow. (see **Figure H**).
- Do not use the prefilled syringe if the liquid is discolored, cloudy, or has large particles. Get a new prefilled syringe.
  - You may see air bubbles in the liquid. This is normal.

■ = Caregiver ONLY

□ = Self-injection and Caregiver

Front

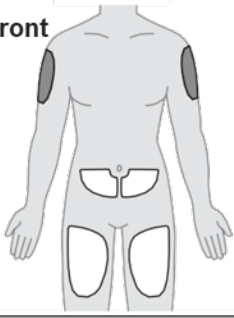

Back

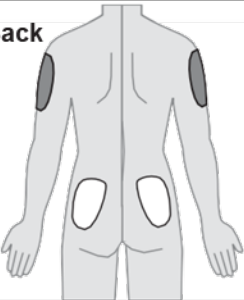

Figure I

**7. Choose an injection site (see Figure I).**

7.a. Choose an injection site around your stomach area (abdomen), buttocks, upper legs (thighs). If a caregiver is giving you the injection, the outer area of the upper arms may also be used (see **Figure I**).

- **Use a different injection site for each injection.**
- **Do not** give an injection in an area of the skin that is tender, bruised, red or hard.

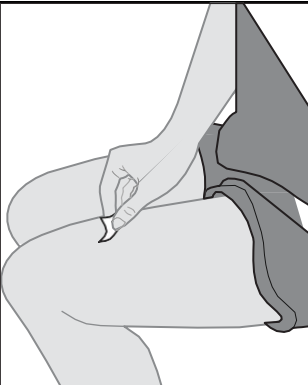

Figure J

**8. Clean the injection site.**

8.a. Clean the skin with an alcohol swab where you plan to give your injection (see **Figure J**).

- **Do not** touch this area again before giving the injection. Let your skin dry before injecting.
- **Do not** fan or blow on the clean area.

## Injecting STEQEYMA

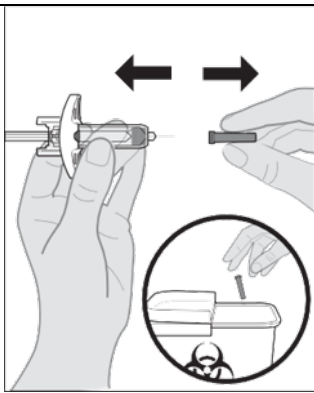

Figure K

### 9. Remove the cap.

9.a. Remove the needle cap when you are ready to inject your STEQEYMA by holding the body of the prefilled syringe in one hand between the thumb and index fingers (see **Figure K**).

- **Do not** hold the plunger while removing the cap.
- You may see a drop of liquid at the tip of the needle. This is normal.

9.b. Throw away (dispose of) the cap right away in an FDA-cleared sharps disposal container (see step **13. Throw away (dispose of) STEQEYMA**).

- **Do not** re-cap the prefilled syringe.
- **Do not** touch the needle. Doing so may result in a needle stick injury.
- **Do not** use the prefilled syringe if it has been dropped without the needle cover in place. Call your doctor, nurse or health professional for further instructions.

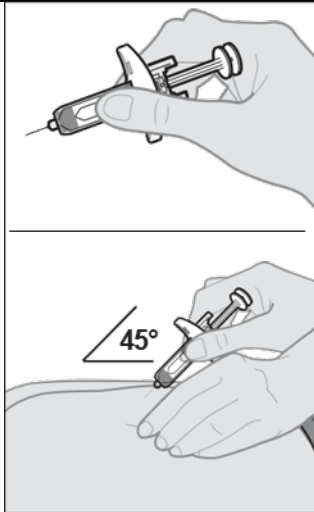

Figure L

### 10. Insert the prefilled syringe into the injection site.

10.a. Hold the body of the prefilled syringe in one hand between the thumb and index fingers (see **Figure L**).

10.b. Gently pinch a fold of skin at the injection site with one hand.

Note: Pinching the skin is important to make sure that you inject under the skin (into the fatty area) but not any deeper (into muscle).

10.c. With a quick and dart-like motion, insert the needle completely into the fold of skin at a 45-degree angle (see **Figure L**).

- **Do not pull back on the plunger rod at any time.**

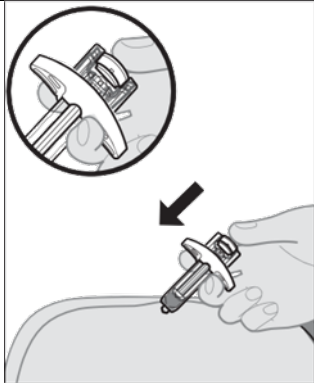

Figure M

### 11. Give the injection.

11.a. After the needle is inserted, release the pinch.

11.b. Inject all of the liquid by using your thumb to push the plunger all the way down (see **Figure M**).

- If the plunger is not fully pressed, the needle guard will not extend to cover the needle when it is removed.

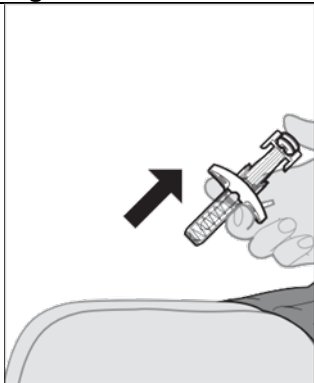

Figure N

### 12. Remove the prefilled syringe from the injection site.

12.a. After the prefilled syringe is empty, slowly lift your thumb from the plunger rod until the needle is completely covered by the needle guard (see **Figure N**).

- If the needle is not covered, proceed carefully to throw away (dispose of) the syringe (see step **13. Throw away (dispose of) STEQEYMA**).
- Some bleeding may occur. This is normal (see step **14. Care for the injection site**).
- **Do not** rub the injection site.

If your dose is 90 mg, you will receive either one 90 mg prefilled syringe or two 45 mg prefilled syringes. If you receive two 45 mg prefilled syringes for a 90 mg dose, you will need to give yourself a second injection right after

the first. Repeat Steps 1 to 12 for the second injection using a new syringe. Choose a different site for the second injection.

#### After the Injection

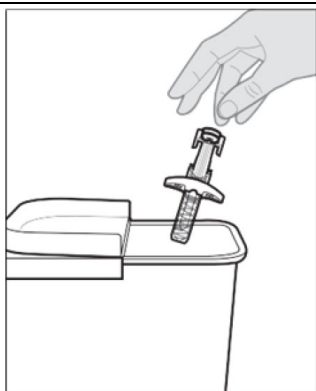

Figure O

#### 13. Throw away (dispose of) STEQEYMA.

13.a. Put the used prefilled syringe in an FDA-cleared sharps disposal container right away after use (see **Figure O**).

- STEQEYMA prefilled syringe is a single-dose syringe and should not be used again.
- **Do not** throw away (dispose of) the prefilled syringe in your household trash.
- If you do not have an FDA-cleared sharps disposal container, you may use a household container that is:
  - made of a heavy-duty plastic,
  - can be closed with a tight-fitting, puncture-resistant lid, without sharps being able to come out,
  - upright and stable during use,
  - leak-resistant, and
  - properly labeled to warn of hazardous waste inside the container.
- When your sharps disposal container is almost full, you will need to follow your community guidelines for the right way to dispose of it. There may be state or local laws about how you should throw away used needles and syringes. For more information about safe sharps disposal, and for specific information about sharps disposal in the state that you live in, go to the FDA's website at: <http://www.fda.gov/safesharpsdisposal>.
- **Do not** dispose of your used sharps disposal container in your household trash unless your community guidelines permit this.
- **Do not** recycle your used sharps disposal container.

#### 14. Care for the injection site.

14.a. If some bleeding occurs, treat the injection site by gently pressing, not rubbing, a cotton ball or gauze to the site and apply an adhesive bandage if needed.

If you have any questions about using your STEQEYMA prefilled syringe, please call your healthcare provider or Company at 1-888-804-3433.

Manufactured by: CELLTRION, Inc. 23, Academy-ro, Yeonsu-gu, Incheon, 22014, Republic of Korea, US License No. 1996

Distributed by: CELLTRION USA, Inc. One Evertrust Plaza Suite 1207, Jersey City, New Jersey, 07302, USA

This Instructions for Use has been approved by the U.S. Food and Drug Administration.

Approved: 12/2024